

NOTES:

1. INTERPRET DRAWING PER:
ASME Y14.5-2009 DIMENSION AND TOLERANCING.
2. REMOVE ALL BURRS AND SHARP EDGES.
3. ALL SURFACES ARE TO BE FREE OF CONTAMINATES PRIOR TO FINISH OR SHIPPING.
4. BAG OR TAG PART(S) WITH
PART NUMBER, APPLICABLE DASH NUMBER, AND REVISION LEVEL.
5. MATERIAL:
6. FINISH:

REVISIONS			
APPD	DESCRIPTION	DATE	REV
AS	PRODUCTION RELEASE	20JUL21	--

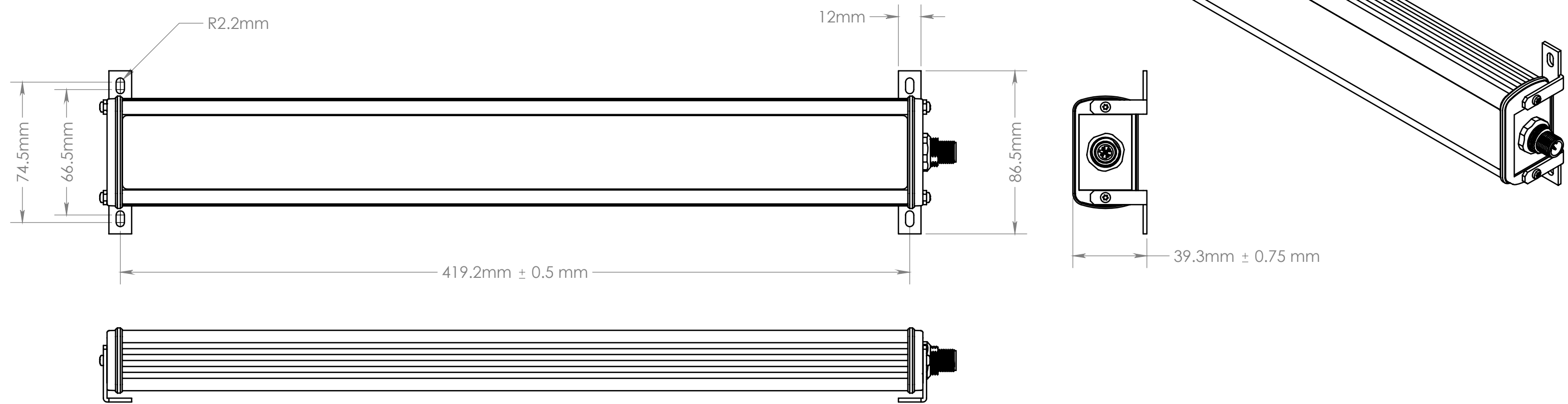

For reference only, subject to change without notice

PROPRIETARY AND CONFIDENTIAL NOTICE
ALL INFORMATION ON THIS SHEET IS THE SOLE PROPERTY OF
ROLL-2-ROLL TECHNOLOGIES.

ALL DIMENSIONS ARE IN MM
 TOLERANCES UNLESS NOTED:
 INCH MILLIMETER
 X.XX +/- 0.01 X.X +/- 0.3
 X.XXX +/- 0.005 X.XX +/- 0.1
 THIRD ANGLE PROJECTION

Roll-2-Roll Technologies STILLWATER, OKLAHOMA	
TITLE	ODC 384-xx QD
DWG NO	ODC 384-xx QD
REV	--

NOTES:

1. INTERPRET DRAWING PER:
ASME Y14.5-2009 DIMENSION AND TOLERANCING.
2. REMOVE ALL BURRS AND SHARP EDGES.
3. ALL SURFACES ARE TO BE FREE OF CONTAMINATES PRIOR TO FINISH OR SHIPPING.
4. BAG OR TAG PART(S) WITH
PART NUMBER, APPLICABLE DASH NUMBER, AND REVISION LEVEL.
5. MATERIAL:
6. FINISH:

REVISIONS			
APPD	DESCRIPTION	DATE	REV
AS	PRODUCTION RELEASE	20JUL21	--

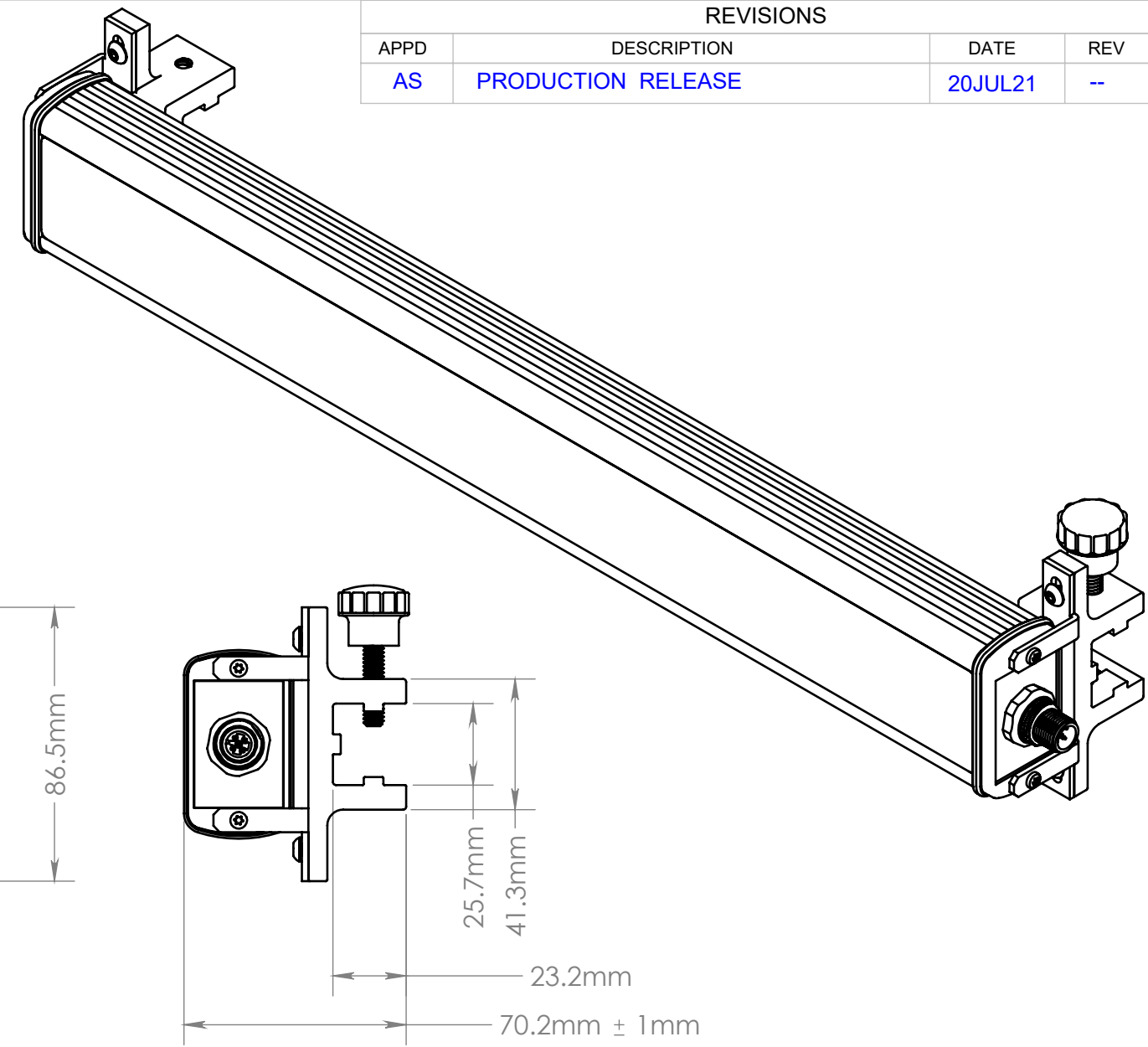
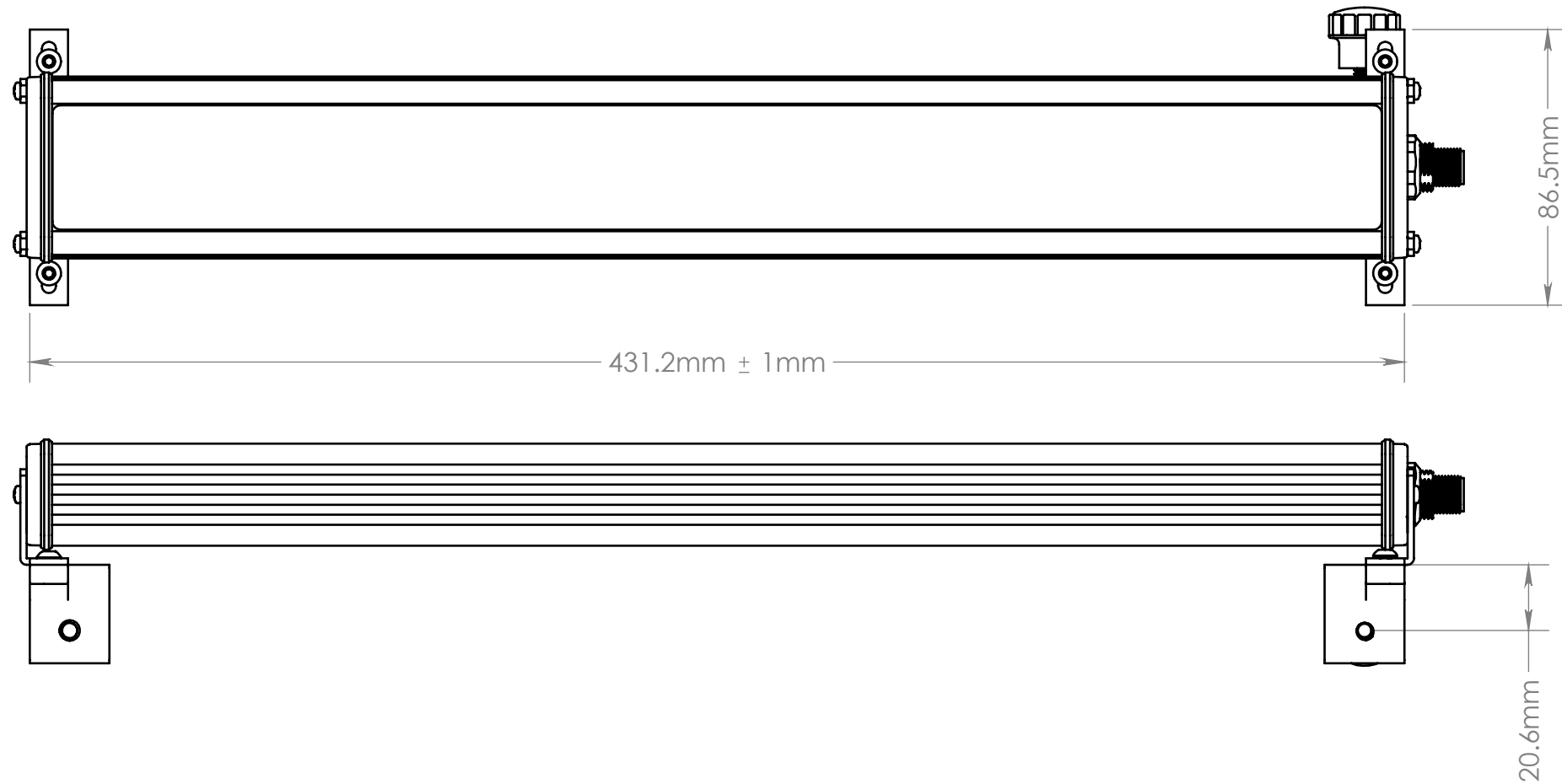

For reference only, subject to change without notice

PROPRIETARY AND CONFIDENTIAL NOTICE
ALL INFORMATION ON THIS SHEET IS THE SOLE PROPERTY OF
ROLL-2-ROLL TECHNOLOGIES.

ALL DIMENSIONS ARE IN MM
TOLERANCES UNLESS NOTED:
INCH MILLIMETER
X.XX +/- 0.01 X.X +/- 0.3
X.XXX +/- 0.005 X.XX +/- 0.1
THIRD ANGLE PROJECTION

Roll-2-Roll Technologies STILLWATER, OKLAHOMA	
TITLE	ODC 384-xx QD w/ 1in Mounting
DWG NO	ODC 384-xx QD
REV	--